

100 - 200 - 300 Series
In-Ceiling & In-Wall Speakers



Performance guide

Good 100 Series 2-way Loudspeakers

All 100 Series loudspeakers incorporate proprietary technologies and materials found in our award-winning Bronze and Radius in-room loudspeakers. 100 Series models are 2-way designs that combine advanced MMP®II bass drivers with Monitor Audio's trademark C-CAM® gold dome tweeter to provide high-performance sound, ease of drive, and wide frequency response and dispersion. Optimum imaging and set-up are established via a pivoting tweeter and high-frequency (+3dB / 0dB / -3dB) level adjustment.

Better 200 Series 2-way Loudspeakers

The step to the 200 Series 2-way loudspeakers is defined by upgrades in driver technology and control features. All 200 Series loudspeakers incorporate proprietary technologies and materials found in our highly acclaimed Silver in-room loudspeakers. 200 Series models marry C-CAM® bass drivers with a more highly specified version of the C-CAM® gold dome tweeter. Optimum imaging and set-up are established via a pivoting tweeter, high-frequency (+3dB / 0dB / -3dB) level adjustment, and Boundary Compensation (on / off) controls. The Series 200 2-way loudspeakers provide extended high-frequency response to 30kHz, and higher output and power handling capacity than the 100 Series 2-way models.

Best 200 Series 3-way Loudspeakers with IDC®

200 Series 3-way loudspeakers feature our unique Inverted Dual Concentric (IDC®) driver module. The IDC® driver module houses a 4-inch C-CAM® midrange and 1-inch C-CAM® gold dome tweeter. 200 Series 3-way models combine C-CAM® bass drivers with an IDC® driver module to provide rich midrange detail, higher system output, greater power handling, and superior vocal intelligibility and sound localization than 200 Series 2-way models. Optimum imaging and set-up are established via the pivoting IDC®, high-frequency (+3dB / 0dB / -3dB) level adjustment, and Boundary Compensation (on / off) controls.

Flagship 300 Series 3-way Loudspeakers with IDC®

Our flagship 300 Series 3-way loudspeakers provide THE BEST Monitor Audio in-wall and in-ceiling loudspeaker options for music and home theater applications. All 300 Series loudspeakers incorporate proprietary technologies and materials found in our award-winning Gold in-room loudspeakers. 300 Series 3-way models marry C-CAM® bass drivers with RST® cone profiles and a cast-aluminum driver chassis with an IDC® driver module to provide deeper bass, higher system output, and greater power handling than the 200 Series 3-way models. Like the 200 Series 3-way loudspeakers, the 300 Series models provide rich midrange detail, and superior vocal intelligibility and sound localization. Optimum imaging and set-up are established via the pivoting IDC®, high-frequency (+3dB / 0dB / -3dB) level adjustment, and Boundary Compensation (on / off) controls. The W380LCR in-wall loudspeaker adds a midrange-frequency (+3dB / 0dB / -3dB) level adjustment for system tuning and a die-cast aluminum front baffle for added rigidity resulting in superior bass articulation.

FX Surround Loudspeakers

The C265FX and C380FX models feature selectable dipole (diffuse sound) or bipole (direct sound) modes for use as rear surround speakers in discreet home theater applications. The surround mode can be selected via a front-mounted switch for both models. The C380FX also features a 12-volt trigger input for automatic surround mode switching. The C265FX and C380FX models use dual 1-inch C-CAM® gold dome tweeters mounted at a precise fixed-angle for optimized performance. The C265FX has a 6.5-inch C-CAM® bass driver. The C380FX has an 8-inch C-CAM® bass driver with RST® cone profile and a cast-aluminum driver chassis.

T2 Stereo Loudspeakers

Our T2 Stereo models feature dual, independent pivoting 1-inch C-CAM® tweeters, and 6.5 inch (C165T2) or 8-inch (C180T2) MMP®II dual wound voice coil bass drivers for high performance stereo sound from a single speaker. The T2 models are ideal for bathrooms, hallways, or any area where space does not allow for stereo pairs.

Performance at a glance		Good	Better	Best	Flagship	FX Surround	T2 Stereo
8" In-Ceiling	C180 In-Ceiling 2-Way	•					
	C280 In-Ceiling 2-Way		•				
	C280LCR In-Ceiling 3-Way			•			
	C380LCR In-Ceiling 3-Way				•		
	C380FX In-Ceiling Surrounds					•	
	C180T2 In-Ceiling Stereo						•
6.5" In-Ceiling	C165 In-Ceiling 2-Way	•					
	C265 In-Ceiling 2-Way		•				
	C265LCR In-Ceiling 3-Way			•			
	C265FX In-Ceiling Surrounds					•	
	C165T2 In-Ceiling Stereo						•
8" In-Wall	W180 In-Wall 2-Way	•					
	W280 In-Wall 2-Way		•				
	W280LCR In-Wall 3-Way			•			
	W380LCR In-Wall 3-Way				•		
6.5" In-Wall	W165 In-Wall 2-Way	•					
	W265 In-Wall 2-Way		•				

Technology guide

Features



Adjustable Response Controls

Optimum imaging and set-up is established via pivoting tweeter, pivoting IDC® driver module, high-frequency, midrange-frequency, and/or boundary compensation controls (depending on model). The Boundary Compensation control provides a gentle midrange roll-off response while preserving the extreme low frequency output when the speaker is placed close to a corner apex of the ceiling and wall.



Patented Tri-Grip® Fixing Clamps

The Tri-Grip® mounting clamps feature three clamping points per dogleg providing triple the clamping surface area than conventional single-point clamping speakers. Our wider three-point clamps provide a better seal between the speaker and the ceiling maximizing bass response and midrange clarity.



Easy Handling During Installation

All models feature protective crossover covers designed to prevent the ingress of loose building materials and dust into the drivers and crossover. The protective covers also make handling easy, and protect the crossover components from damage during installation.



Ready for Action in Humid Environments

All models will resist high humidity and ultraviolet light and can be placed in bathrooms, pool areas, and outdoors.

New Construction Brackets

Accessory New Construction Brackets are available for all models to help mark speaker placement during framing and prior to sheetrock application. The brackets will span up to 24-inch stud spacing. New Construction Brackets are not required for retrofit applications.



Painting

A paint mask and additional grille scrim are provided for color matching to any décor.

Technology



MMP®II

MMP®II (Metal Matrix Polymer) driver cones have a polypropylene base loaded with metallic particles for a rigid and responsive structure. A high-pressure, injection molded process achieves a different cone thickness at critical points to optimize stiffness and consistency resulting in superior sonic performance.



C-CAM®

C-CAM® (Ceramic-Coated Aluminum Magnesium) is an innovative alloy material originally developed by the aerospace industry for its use as blades in jet engines where low mass and extreme rigidity are required. Monitor Audio C-CAM® drivers are formed from an alloy of aluminum and magnesium, which is made into the cone shape by a two stage high pressure forming technique. After forming the shape, a layer of pure ceramic (alumina) is depleted onto the surfaces, to give a completely rigid exterior. The resulting properties of the C-CAM® material are lightning-fast response for incredible clarity and extreme rigidity for low distortion.



RST®

The dimpled surface of C-CAM® drivers with the RST® (Rigid Surface Technology) cone profile provides the conical shape of driver cones with another degree of resistance to mechanical bending forces. The dimples significantly increase cone rigidity and allow us to use thinner and therefore lighter C-CAM® cones. The dimpled RST® pattern also displaces any standing waves that can propagate across the cone surface. C-CAM® drivers with the RST® cone profile provide speed and accuracy, while virtually eliminating distortion caused by cone-flex during operation.

Technology at a glance

	C-CAM Tweeter	MMP II Woofer	C-CAM Woofer	RST Technology
100 Series	•	•		
200 Series	•		•	
300 Series	•		•	•

Inverted Dual Concentric Driver module

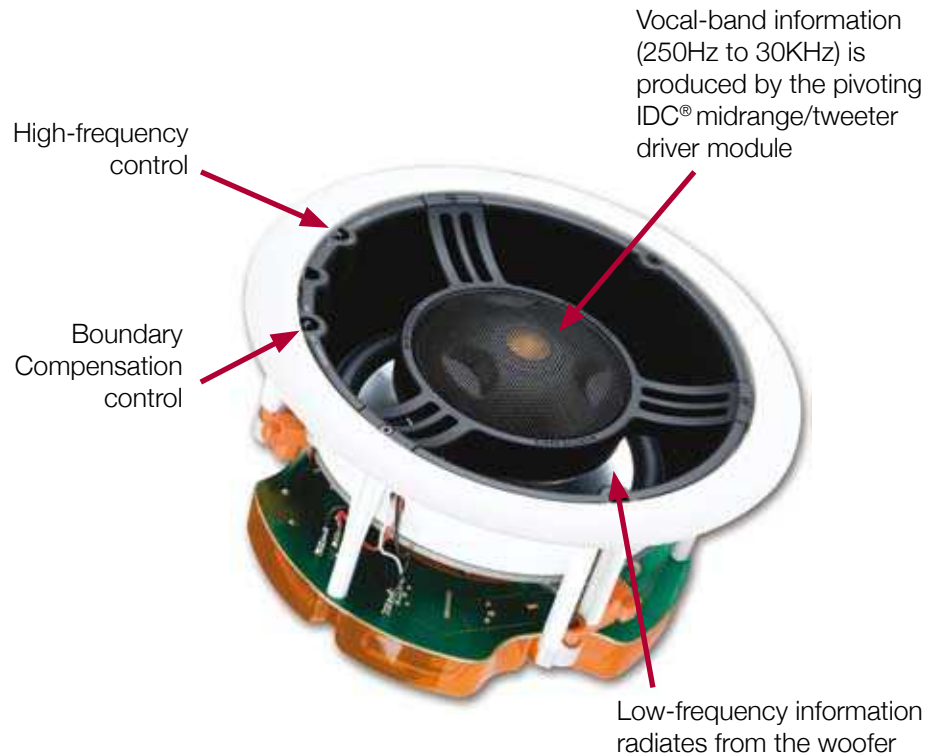

At the heart of the new in-ceiling and in-wall LCR models is a unique Inverted Dual Concentric (IDC®) pivoting midrange/tweeter module with up to 18 degrees of play. Speakers can be discreetly positioned, and then the sound can be directed into the desired listening zone by pivoting the IDC® driver module to maximize performance. These models are true 3-way designs and offer superior performance and flexibility over typical 2-way or fixed angle speaker designs.

Typical 2-Way Speakers

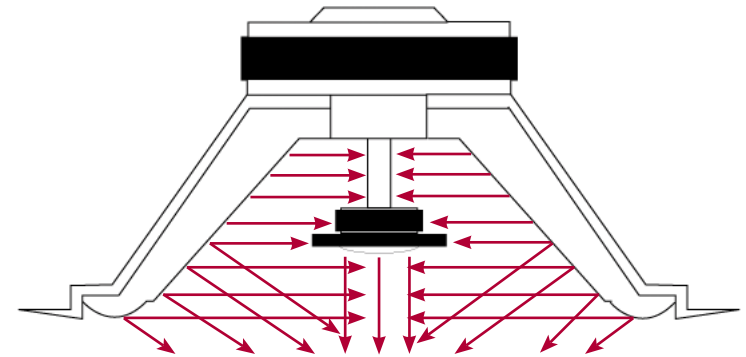

Monitor Audio LCR Speaker with IDC®

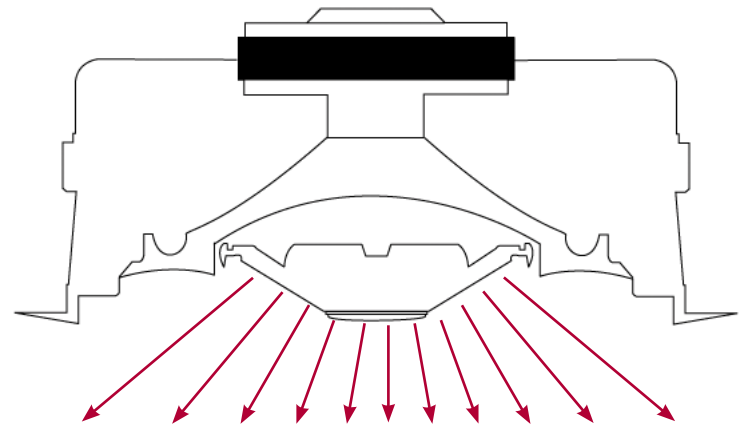

Only Monitor Audio offers the innovative IDC® driver module. Our special inverted 4" midrange driver provides superior dispersion, while enabling the mid-range cone and tweeter dome to be set as far forward as possible, allowing clear acoustic 'sighting' of the desired listening zone and negating undesirable diffraction effects. It's impossible to avoid diffraction effects with two-way designs where significant vocal band information comes from a bass driver set 3" to 6" back from the speaker grille.

Inverted Dual Concentric Driver module

Our 'LCR' models are the best choice as front speakers in theater and music applications

Two of the most important attributes of front speakers for the reproduction of movies and music are Vocal Band Intelligibility and Front Sound Localization.

Vocal Band Intelligibility

Is the ability to hear every sound clearly and without strain. This is difficult when dialog is competing with the film score and loud sound effects such as explosions and collisions. When you can't hear the dialog clearly, it's difficult to follow the movie or with music, to understand what the vocalist is singing.

Front Sound Localization

Is the ability to match the "sonic picture" with on-screen action. For example, if an automobile travels from the left side of the screen to the right side and the sound of the automobile pans from left to right matching the on-screen action, the scene becomes believable. Likewise with music, creating an accurate "stereo image" of the band with all instruments placed properly in space will add realism to your music listening experience.

Superior Clarity and Imaging

The IDC® driver module houses a 4-inch C-CAM® midrange and 1-inch C-CAM® dome tweeter. We selected a 4-inch midrange driver to enable a low crossover point from the midrange to the bass driver. Directional information radiates from the IDC® driver module, which covers a wide frequency range from 250Hz to 30KHz. This is of paramount importance for vocal band intelligibility and accurate sound localization because our unique IDC® design prevents diffraction effects that can impact midrange clarity and imaging.

High Power Handling and Output

The 4-inch midrange driver utilizes an over-sized 1.5-inch edge-wound voice coil. Separate tweeter and midrange Neodymium magnet systems provide high overall power handling and efficiency. The IDC® driver module operates in its own completely sealed chamber to provide accurate damping and perfect acoustic alignment.

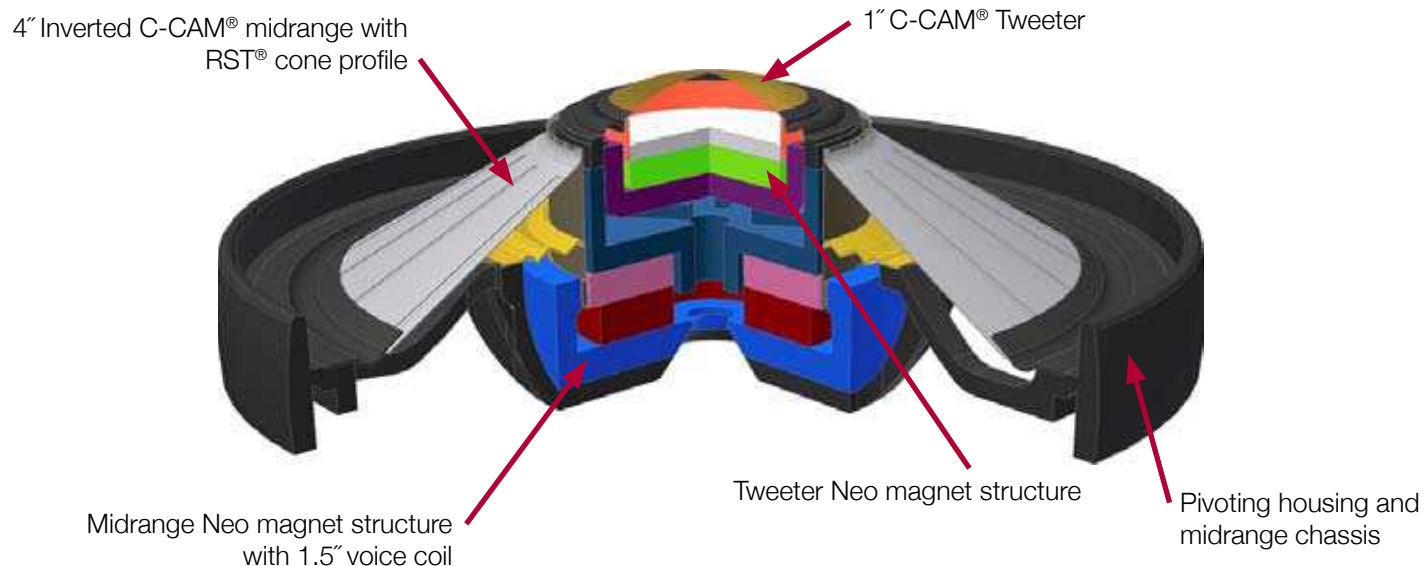

8" In-Ceiling speakers

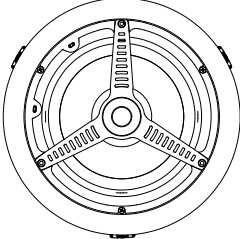
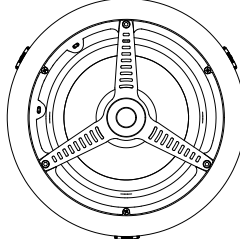
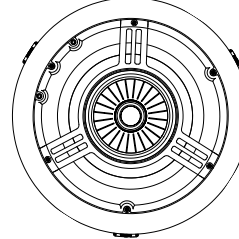
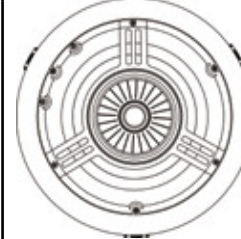
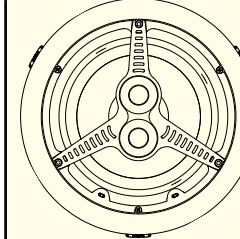
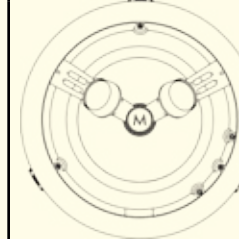

	8" Full Range Speakers				8" Special Application Speakers	
	Good	Better	Best	Flagship	T2 Stereo	FX Surrounds
	C180 	C280 	C280LCR 	C380LCR 	C180T2 	C380FX 
Frequency Response	50Hz - 25KHz	50Hz - 30KHz	50Hz - 30KHz	45Hz - 30KHz	60Hz - 25KHz	45Hz - 30KHz
Impedance (nominal)	6 Ohms	6 Ohms	6 Ohms	6 Ohms	6+6 Ohms	6 Ohms
Sensitivity (1W@1M)	90dB	90dB	90dB	90dB	89dB	90dB
Power Handling (R.M.S)	120 W	120 W	130 W	150 W	120 W	150 W
Recommended Amp	10 - 120 W	15 - 120 W	20 - 130 W	20 - 150 W	10 - 120 W	20 - 150 W
Driver Configuration	8" MMP II cone bass driver 1" C-CAM pivoting tweeter	8" C-CAM cone bass driver 1" C-CAM pivoting tweeter	8" C-CAM cone bass driver 4" C-CAM inverted mid-range driver 1" C-CAM tweeter	8" C-CAM cone bass driver featuring RST 4" C-CAM inverted mid-range driver 1" C-CAM tweeter	8" MMP II cone bass driver 2 x 1" C-CAM pivoting tweeters	8" C-CAM cone bass driver 2 x 1" C-CAM fixed angle tweeters
IDC Driver Module	-	-	✓	✓	-	-
Overall Diameter	11 1/4" (286mm)	11 1/4" (286mm)	11 1/4" (286mm)	11 1/4" (286mm)	11 1/4" (286mm)	11 1/4" (286mm)
Mounting Depth	4 3/4" (121mm)	4 3/4" (121mm)	6 1/16" (154mm)	6 3/16" (157mm)	4 3/4" (121mm)	6 3/16" (157mm)
Cut-out Hole Diameter	9 3/4" (247mm)	9 3/4" (247mm)	9 3/4" (247mm)	9 3/4" (247mm)	9 3/4" (247mm)	9 3/4" (247mm)
H.F. Level Switch (+3db/0dB/-3dB)	✓	✓	✓	✓	✓	✓
Boundary Compensation switch	-	✓	✓	✓	-	-
Di-pole/Bi-pole Switching	-	-	-	-	-	✓
Pre-Construction Bracket	CB8	CB8	CB8	CB8	CB8	CB8
Timbre-Matching	Bronze / Radius	Silver	Silver	Gold	All Ranges	All Ranges



CB8 construction bracket fits all 8" In-ceiling speakers

6.5" In-Ceiling speakers



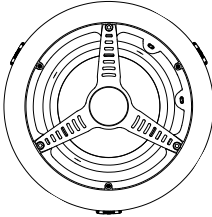
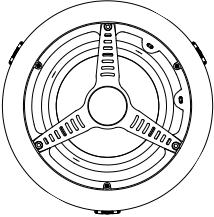
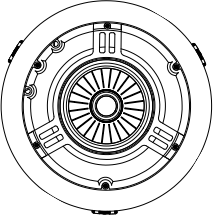
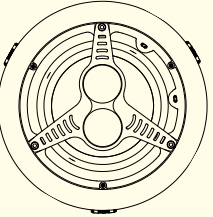
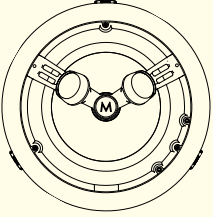

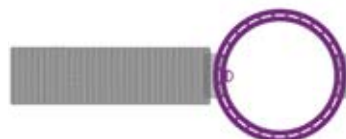
	6.5" Full Range Speakers			6.5" Special Application Speakers	
	Good	Better	Best	T2 Stereo	FX Surround
	C165 	C265 	C265LCR 	C165T2 	C265FX 
Frequency Response	60Hz - 25KHz	60Hz - 30KHz	50Hz - 30KHz	60Hz - 25KHz	60Hz - 30KHz
Impedance (nominal)	6 Ohms	6 Ohms	6 Ohms	6+6 Ohms	6 Ohms
Sensitivity (1W@1M)	88.5dB	88.5dB	90dB	89dB	88.5dB
Power Handling (R.M.S)	65 W	75 W	120 W	65 W	120 W
Recommended Amp	10 - 65 W	15 - 75 W	15 - 120 W	10 - 65 W	15 - 120 W
Driver Configuration	6.5" MMP II cone bass driver 1" C-CAM pivoting tweeter	6.5" C-CAM cone bass driver 1" C-CAM pivoting tweeter	6.5" C-CAM cone bass driver 4" C-CAM inverted mid-range driver 1" C-CAM tweeter	6.5" MMP II cone bass driver 2 x 1" C-CAM pivoting tweeters	6.5" C-CAM cone bass driver 2 x 1" C-CAM fixed angle tweeters
IDC Driver Module	-	-	✓	-	-
Overall Diameter	9 13/16" (250mm)	9 13/16" (250mm)	9 13/16" (250mm)	9 13/16" (250mm)	9 13/16" (250mm)
Mounting Depth	4 7/16" (112mm)	4 7/16" (112mm)	5 7/8" (149mm)	4 7/16" (112mm)	5 7/8" (149mm)
Cut-out Hole Diameter	8 5/16" (211mm)	8 5/16" (211mm)	8 5/16" (211mm)	8 5/16" (211mm)	8 5/16" (211mm)
H.F. Level Switch (+3db/0dB/-3dB)	✓	✓	✓	-	✓
Boundary Compensation switch	-	✓	✓	-	-
Di-pole/Bi-pole Switching	-	-	-	-	✓
Pre-Construction Bracket	CB6	CB6	CB6	CB6	CB6
Timbre-Matching	Bronze / Radius	Silver	Silver	All Ranges	All Ranges



CB6 construction bracket fits all 6.5" In-ceiling speakers

8" and 6.5" In-Wall speakers

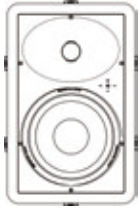
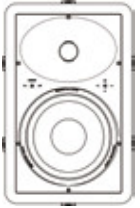

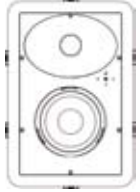
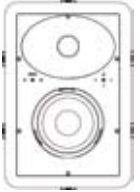
	8" Full Range Speakers				6.5" Full Range Speakers	
	Good	Better	Best	Flagship	Good	Better
	W180 	W280 	W280LCR 	W380LCR 	W165 	W265 
Frequency Response	50Hz - 25KHz	45Hz - 30KHz	45Hz - 30KHz	45Hz - 30KHz	60Hz - 25KHz	55Hz - 30KHz
Impedance (nominal)	6 Ohms	6 Ohms	6 Ohms	6 Ohms	6 Ohms	6 Ohms
Sensitivity (1W@1M)	90dB	90dB	90dB	90dB	88.5dB	88.5dB
Power Handling (R.M.S)	120 W	120 W	130 W	150 W	65 W	75 W
Recommended Amp	10 - 120 W	15 - 120 W	20 - 130 W	20 - 150 W	10 - 65 W	10 - 75 W
Driver Configuration	8" MMP II cone bass driver 1" C-CAM gold tweeter	8" MMP II cone bass driver 1" C-CAM gold tweeter	8" C-CAM cone bass driver 4" C-CAM inverted mid-range driver 1" C-CAM gold tweeter	8" C-CAM cone bass driver with RST 4" C-CAM inverted mid-range driver 1" C-CAM gold tweeter	6.5" MMP II cone bass driver 1" C-CAM gold tweeter	6.5" C-CAM cone bass driver 1" C-CAM gold tweeter
IDC Driver Module	-	-	✓	✓	-	-
Overall Diameter	16 5/8 x 10 5/8" (423 x 270mm)	16 5/8 x 10 5/8" (423 x 270mm)	16 5/8 x 10 5/8" (423 x 270mm)	16 5/8 x 10 5/8" (423 x 270mm)	14 1/2 x 9 13/16" (368 x 249mm)	14 1/2 x 9 13/16" (368 x 249mm)
Mounting Depth	3 7/8" (99mm)	3 7/8" (99mm)	3 7/8" (99mm)	3 7/8" (99mm)	3 9/16" (90mm)	3 9/16" (90mm)
Cut-out Hole Diameter	15 1/4 x 9 3/16" (387 x 234mm)	15 1/4 x 9 3/16" (387 x 234mm)	15 1/4 x 9 3/16" (387 x 234mm)	15 1/4 x 9 3/16" (387 x 234mm)	13 1/16 x 8 3/8" (332 x 212.5mm)	13 1/16 x 8 3/8" (332 x 212.5mm)
H.F. Level Switch (+3db/0dB/-3dB)	✓	✓	✓	✓	✓	✓
Midrange Level Switch	-	-	-	✓	-	-
Boundary Compensation switch	-	✓	✓	✓	-	✓
Pre-Construction Bracket	WB8	WB8	WB8	WB8	WB6	WB6
Timbre-Matching	Bronze / Radius	Silver	Silver	Gold	Bronze / Radius	Silver



WB8 construction bracket fits all 8" In-wall speakers



WB6 construction bracket fits all 6.5" In-wall speakers

In-Wall speakers



W380LCR Front

- A** Pivoting IDC® Midrange/Tweeter Driver Module
- B** High-Frequency Control
- C** Midrange-Frequency Control
- D** 8" C-CAM® Woofer with RST® Cone Profile
- E** Rigid Cast-Aluminum Front Baffle
- F** Boundary Compensation Control

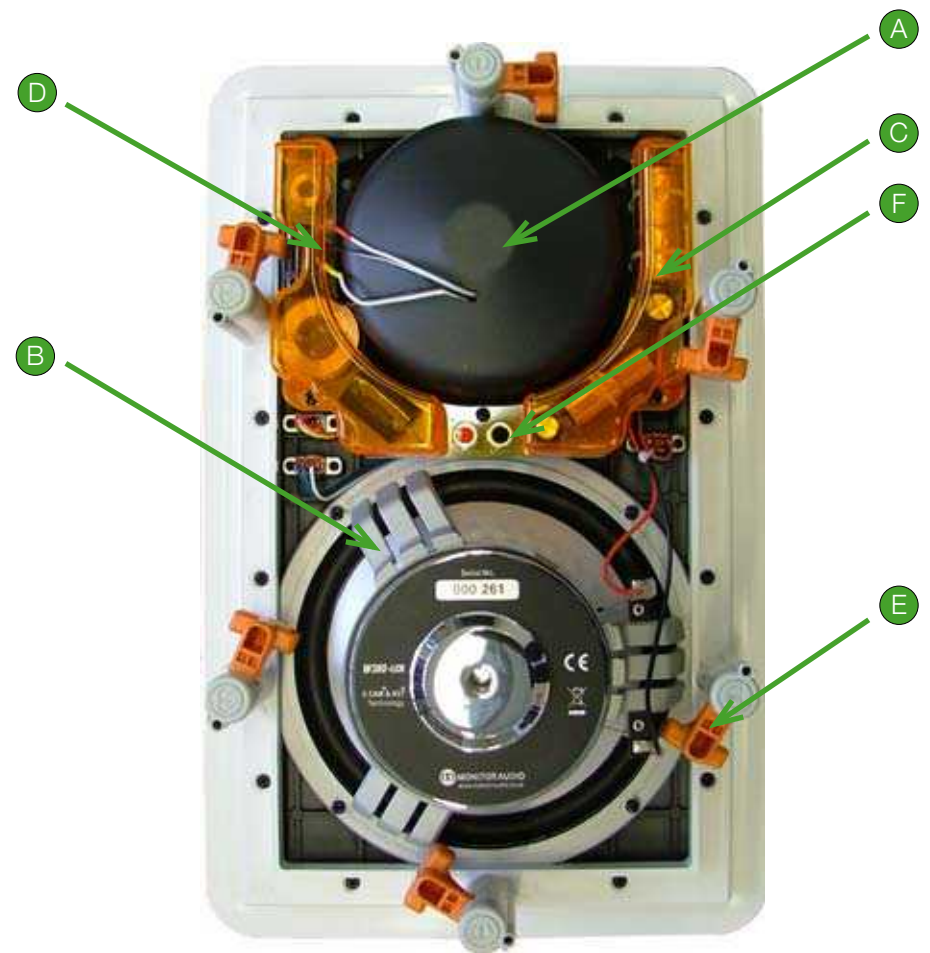

W380LCR Back

- A** IDC® Driver Module Enclosure
- B** Rigid Cast-Aluminum Woofer Chassis
- C** Sophisticated 4th Order Crossover
- D** Protective Crossover Cover
- E** Patented Tri-Grip Mounting Clamps
- F** Gold-plated Cable Terminals

Theater systems

In-Ceiling 5.1 Theater

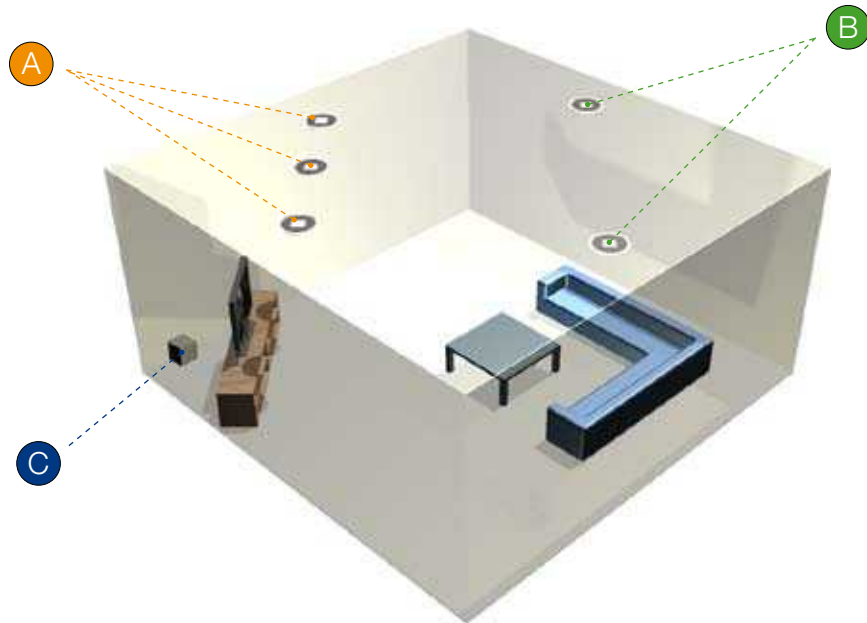

In-Wall 5.1 Theater

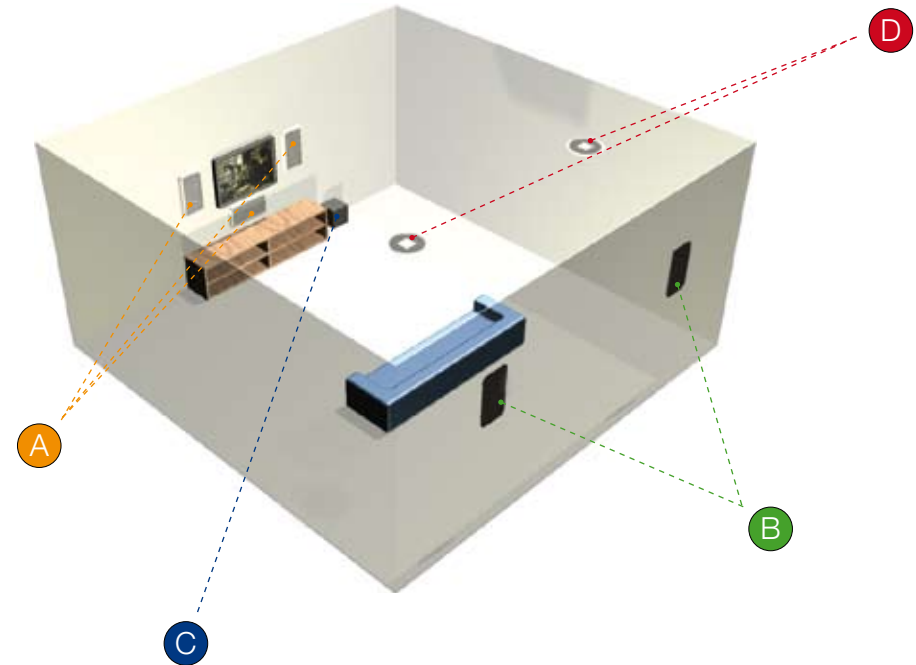

- A** Front Left-Center-Right main loudspeakers
- B** Rear Left-Right surround loudspeakers
- C** Add your choice of Monitor Audio subwoofer to complete the theater
- D** You can use in-wall front LCR loudspeakers with in-ceiling left-right surrounds if desired

Theater at a glance	Front Left - Center - Right Speakers	Rear Surround Speakers
8" In-Ceiling Loudspeakers	C180, C280, C280LCR, C380LCR	C380FX , or use same as front speaker choice
6.5" In-Ceiling Loudspeakers	C165, C265, C265LCR	C265FX , or use same as front speaker choice
8" In-Wall Loudspeakers	W180, W280, W280LCR, W380LCR	Use same as front speaker choice or C380FX
6.5" In-Wall Loudspeakers	W165, W265	Use same as front speaker choice or C265FX

Best choice speakers are indicated by Bold, colored type

6.1 and 7.1 Theaters:

Use three surround loudspeakers for 6.1 theaters and use four surround loudspeakers for 7.1 theaters

Create your theater





Monitor Audio Ltd
Unit 2, 24 Brook Road
Rayleigh, Essex
SS6 7XL
England
Tel: 01268 740580
Fax: 01268 740589
Email: info@monitoraudio.co.uk

monitoraudio.co.uk
monitoraudiousa.com